

Complete Catalog of

Frontenac Cylinder Heads Fronty-Ford

*Speed Specialties
and Racing Units*

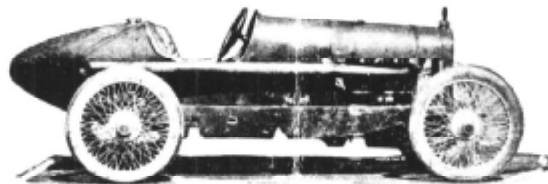

CHEVROLET BROS. MFG. Co.

410 West Tenth St.
INDIANAPOLIS, IND., U. S. A.

OCTOBER 15, 1923.



THIS VOIDS ALL FORMER PRICE LISTS

Frontenac Cylinder Head

for Any Type of Ford

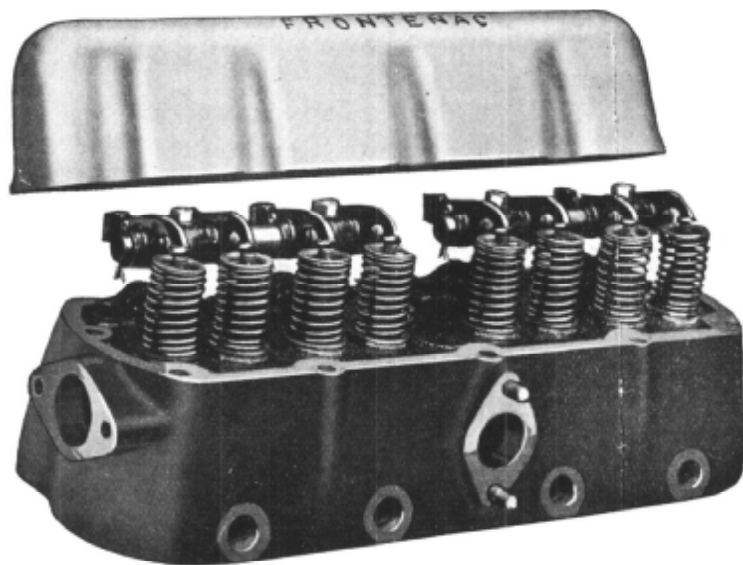

Frontenac Cylinder Heads are made in three models, the difference being in size of the combustion chambers. Valves in Model T and S Heads have a semi-steel head, carbon steel stem, both of which have proven best for commercial use. Valves in Model R Heads for racing are made of Tungsten steel. The valves are $1\frac{1}{8}$ " with a $\frac{3}{8}$ " lift. Rocker Arms are of special design, carrying an offset of $1\frac{1}{4}$ to 1 ratio. They are drop-forged of open-hearth steel, carbonized and hardened and equipped with a bronze bushing which is removable. Rocker Arm shaft is made of steel, carbonized, hardened and ground.

The Frontenac Cylinder Head gave the Fronty-Ford the speed, power and stamina to qualify and finish in 5th place, making an average of 82:58 M. P. H. in the 500-Mile Race at the Indianapolis Speedway, May 30, 1923. This is an official record under A. A. A. sanction and not a mere boast. No other cylinder head for Ford ever approached this performance. No further recommendation is necessary for the Fronty.

In the Ford owner who seeks the performance of large cars, the salesman who must cover a large territory quickly and the truck owner who wants more power and economy of operation, dealers find a ready market for Frontenac Cylinder Heads. The Fronty greatly increases power and gasoline mileage, and eliminates vibration and overheating. The Fronty-equipped motor can easily be throttled to 5 miles an hour-then accelerated to 40 miles an hour in 16 seconds! By actual tests, 20 to 25 miles per gallon of gasoline may be had.

Push Rod is round steel $\frac{3}{8}$ " stock, hardened at cam end, with hardened, adjusting nut in upper end held in place by lock nut. Extra long valve springs are oil tempered. Removable valve guides are extra long, standing 1 inch above upper surface of head.

Manifold passageways to and from inlet and exhaust valves are larger than the valve area and are free from abrupt bends or corners. Exhaust and inlet passageways and valve seats are surrounded by water. Water capacity of head, one gallon. No water pump is needed on the Frontenac Cylinder Head.

Frontenac Cylinder Heads are complete. Extra parts and other equipment is not needed.

- 210. Model T Head for Ford Roadsters, Touring Cars, Coupes, Sedans and Trucks. Equipment includes $1\frac{1}{4}$ " Horizontal Carburetor, vacuum tank, spark plugs, ignition wires and exhaust manifold. Price, complete _____ \$115.00
- 211. Model S Head for Ford converted into Speedster, equipment same as the Model T Head. Price _____ \$115.00
- 212 Model R Head for Ford converted into Racing Car. Price _____ \$100.00

NOTE-Racing exhaust manifold and carburetor is extra equipment on Model R Head for racing.

Competing with the world's foremost engineers and designers of automobiles, Louis Chevrolet achieved the enviable record of being the only designer whose cars won two successive 500-mile races at the Indianapolis Speedway, a feat never before accomplished in the history of the course. Louis and Arthur Chevrolet, world-famous racing drivers and engineers of a score of years, are the designers, patentees and makers of the Frontenac Cylinder Head for Fords which is now available to all Ford owners.

The Fronty-Ford Racing Car

Will Win for You

You MUST win. Your skill, plus Fronty-Ford performance will get you in on the big money every time! The Fronty-Ford will stand up under the most severe driving. Lightning get-away and great speed are characteristic of the Fronty-Ford. It is the most consistent and sensational performer on half-mile dirt tracks ever built. The best proof of the Fronty-Ford speed and reliability is found in its performance in the 500-mile race May 30, 1923, in which it placed fifth, defeating all foreign entries and many of the best American entries.

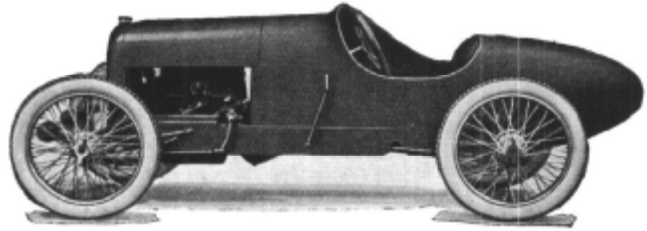

SPECIFICATIONS :

Frame: Standard Ford frame shortened for 88" wheel base. (Longer wheel base for road-racing optional.) Front Axle: Standard Ford I-Beam shortened for 5" offset to the left. (Standard width optional.) Steering Knuckles: Our special steering Knuckles and spindles made of Chrome Nickel steel, guaranteed against breakage. Front Wheel Bearings: Timken Roller. Front Radius Rods: our special side radius rods, Front Underslinging: our special front brackets. Rear Axle: standard Ford rear axle assembly, shortened for 5" offset to the left. (Standard width optional.) Rear Wheel Bearings: New Departure ball bearings No. 1211 mounted in our special mounting. Wheels: special racing 28x4, straight side, depressed center rim; no rim-ring used; equipped with winged hub caps for quick change. Axle Shafts: special oversize, $1\frac{1}{8}$ axles made of Chrome Vanadium steel, guaranteed against breakage. Springs: special weight Ford style springs made of high-grade alloy steel. Shock Absorbers: Hartford. Rear Underslinging: our own method. Steering Gear: our special balanced pressure gear. Steering Wheel: our special spring steel spoke wheel.

Radiator: Fronty-Ford model, made with Fedders' high-efficiency core. Motor: Fronty-Ford racing motor. (See motor specifications.) Body: One-man steel frame body. Scientifically designed to reduce wind resistance and to give car proper balance. Seat trimmed with high-grade upholstery. Tanks: Double tank in rear of body. Gasoline capacity 12 gallons. Oil capacity, 3% gallons. Tanks equipped with bar caps and piped for air pressure. Feed (gasoline): pressure. Feed (oil): pressure.

Transmission: standard -Ford, the fastest for quick get-away. Gear Ratio: optional, 3-1 for straightaway racing, 3.63-1 for mile tracks, or 4-1 for $\frac{1}{4}$ -mile tracks. Thread: optional 51" throughout, offset 5" to the left or standard. Wheel Base, 88" (longer if desired). Weight: 1200 lbs. Speed: 30 seconds on $\frac{1}{4}$ -mile track; 48 seconds on mile track; 100 M. P. H. on straightaway. Color: optional.

214 Price, F.O.B _____ \$2000.00

A FEW FRONTY-FORD RECORDS AND ACHIEVEMENTS

WINCHESTER, IND., MAY 29, 1922

Ralph Ormsby turned half-mile track in 29 seconds flat with Fronty-Ford. World's record for half-mile dirt truck against any competition.

INDIANAPOLIS SPEEDWAY, MAY 30, 1922

Fronty-Ford driven by Glenn Howard averaged 80 M. P. H. for 420 miles. Jack Curtner drove Fronty-Ford 440 miles for an average of 85 M. P. H.

CLEVELAND, OKLA., MAY 29, 1922

Using Frontenac Head, Dick Calhoun lowered his own state record, turning one mile on half-mile track in 1:00 1-2.

TOLEDO, O., JUNE 4, 1922

One-Hundred mile dirt track championship race; first, Fronty-Ford driven by Ralph Ormsby; second, Fronty-Ford driven by C. W. Belt.

UNIONTOWN SPEEDWAY, PA., JUNE 19, 1922

A. A. A. Sanction Meet. Jack Curtner qualifies for race at an average of 92 M. P. H.

TOLEDO, O., SEPT. 17, 1922

Hundred mile race won by Homer Ormsby in Fronty-Ford; second, Ralph Ormsby in Fronty-Ford. Fastest lap, 48 2-5 seconds by Ralph Ormsby.

INDIANAPOLIS, IND., NOV. 11, 1922

Opening race of the new Hoosier Speedway, 75 miles, won by Ralph Ormsby in Fronty-Ford; second, Homer Ormsby, in Fronty-Ford; third, J. Guinta in Fronty-Ford. A clean sweep for the Frontys-first and second cars only cars that ran race without stop.

INDIANAPOLIS, MAY 30, 1923

A. A. A. Sanction Meet. Barber-Warnock Special equipped with Frontenac Cylinder head wins 5th place in 500-mile sweepstakes averaging 82:58 M. P. H., defeating all foreign entries and many of the costliest American cars.

WINCHESTER, IND., JULY 4, 1922

Ralph Ormsby driving Fronty-Ford wins 60-mile race establishing new records for the distance, 40 miles in 39.32; 60 miles in 60.46.

SAN LUIS OBISPO, CAL., SEPT. 3, 1923

A. A. A. Sanction No. 1411. Fred H. Luelling driving Fronty-Ford broke all dirt track competitive records from one to sixty miles-seven in all. Time, 60 miles, 47 3-5; one mile, 42 1-5; five miles, 3.48 4-5; ten miles, 7.40; fifteen miles, 11.40 2-5; twenty-five miles, 19.56 1-5. H. Fredrickson driving Fronty-Ford took second. His time was 60 miles in 48.54 2-5.

WINCHESTER, IND., SEPT. 16, 1923

Chance Kinsley driving Fronty-Ford in 100-mile race turned fastest lap ever made on, a one-half mile track by cars of 183 cubic inch displacement. Time, 28 2-6.

To the Frontenac Cylinder Head goes the honor of these remarkable light-car achievements. It is the power, speed and flexibility of the Fronty Head that carries Fronty-Ford drivers to victory. Every racing driver who has driven a Fronty-equipped motor is warm in his praise for Frontenac cylinder heads.

Speed Specialties

Fronty-Ford Racing Motor

This is the motor included in specifications for the Fronty-Ford Racing Car. It embodies the experience of many years in designing motors that will "produce the goods" in racing competition. All parts are thoroughly tested before the motor leaves the factory.

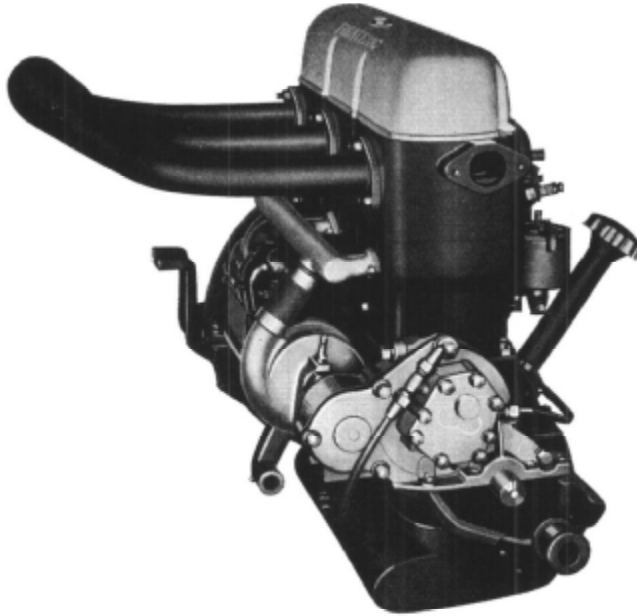

SPECIFICATIONS:

Frontenac Cylinder Head, Model R; special racing exhaust manifold; special Zenith carburetor (Model L-6) ; Ford cylinder block (starter type); special racing pistons, special racing piston rings, special piston pins. Ford connecting rods, machined and balanced accurately; special heavy oversize crankshaft; special water pump and magneto bracket, Scintilla magneto and coupling; special oil pump and oiling system (pressure feed); Ford crankcase; special sub-base oil reservoir. Ford camshaft with extension for driving oil pump; Ford camshaft bearings; special nickel steel camshaft gear; Ford transmission and bands; fly-wheel cut to 10" diameter and balanced ; special ball bearing ball cap.

215. Price complete, ready to set in frame _____ \$800.00

OVERSIZE CRANKSHAFT FOR RACING MOTOR

This heavy crankshaft was especially designed to overcome the breakage of the regular size shaft, and is fully guaranteed against breakage for one year. The main bearings are $1\frac{5}{8}$ " diameter, instead of $1\frac{1}{4}$ ", and the connecting rod bearings are $1\frac{3}{8}$ ", instead of $1\frac{1}{4}$ ". It is drilled for oil pressure system and is perfectly balanced, machined all over, made out of a solid billet of Chrome Nickel steel, heat-treated and ground to accurate dimensions. The greatest help to racing motor we have ever designed.

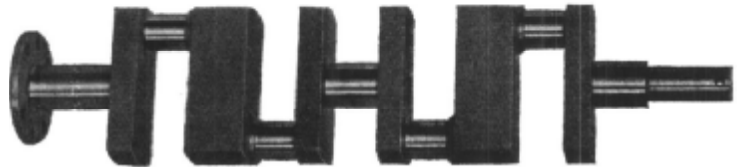

216. Price _____ \$175.00

Because they themselves have driven racing cars for a score of years, Arthur and Louis Chevrolet realize the necessity of quality, uniformity and strength in every part of a racing machine. Rigid tests are given every Fronty product before it is placed on the market, and close inspection is given every piece before it leaves the factory.

MAIN BEARING CAP, faced and drilled, but not bored. (When using special heavy crankshaft it is necessary to use these caps, boring them out with cylinder block.)

217. Price per set (3 to a set) with bolts-----\$9.00

CONNECTING ROD, bored for special heavy crankshaft, babbitted and reamed to fit shaft. Accurately balanced. Four to set.

218. Price _____ \$30.00

CYLINDER BLOCK fitted with special heavy crankshaft, bearing caps and connecting rods. All bearings fitted, rods balanced, pistons, rings and pins, water pump and bracket, complete oiling system installed.

219. Price _____ \$425.00

CYLINDER BLOCK fitted with special heavy crankshaft, bearing caps, connecting rods balanced, bored out and babbitted, bearings fitted and adjusted. 220. Price _____ \$270.00

and Racing Units

SPECIAL RACING PISTON

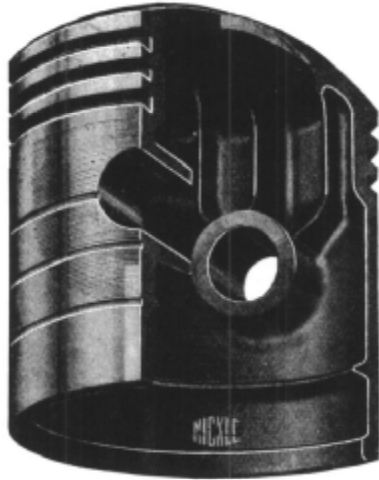

This is the only piston that will stand up under the strain of the Fronty-Ford Racing Car. Made of extra strong aluminum and nickel alloy, accurately machined, and grooved for three $\frac{1}{8}$ " piston rings. Very light. Guaranteed against breakage.

221. Price, per set of four _____\$32.00

BU-NITE STEEL BAND FOR TOURING CARS AND SPEEDSTERS

Especially designed for replacement on Ford motors. Will eliminate most of the vibration and save gasoline and oil. Will not slap or pump oil, because it conforms to cylinder walls. Especially good for use on cars equipped with special cylinder heads or speedster bodies.

224. Price, per set of four _____\$25.00



SPECIAL PISTON PINS, made of electric chrome vanadium steel, lighter than standard pin. Guaranteed against breakage.

222. Price, each _____\$2.00

HIGH-COMPRESSION RACING PISTON RINGS, $\frac{1}{8}$ " wide. Perfectly machined from the best gray iron castings.

223. Price, each _____\$0.75

WATER PUMP AND MAGNETO BRACKET

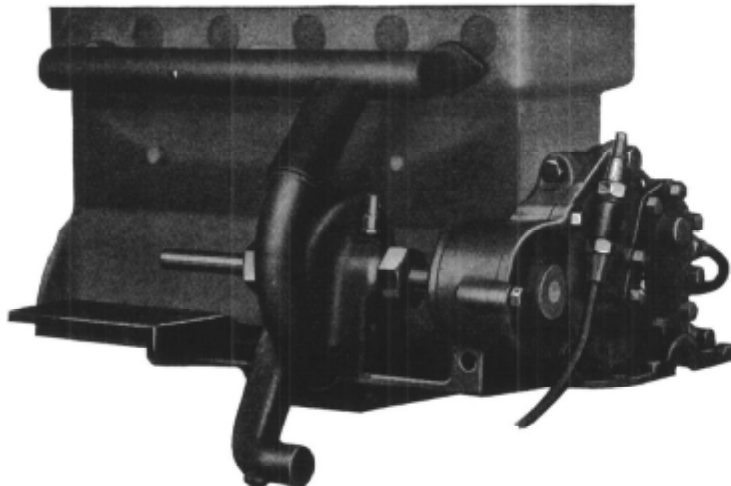

This water pump and magneto bracket was specially designed by us for the Ford racing motor. It is made entirely of aluminum, and is absolutely the best outfit of this kind on the market today. The shaft, which is mounted on ball bearings, is made of chrome nickel steel, front gear cover equipped with pad to receive oil puma.

226. Price _____\$45.00

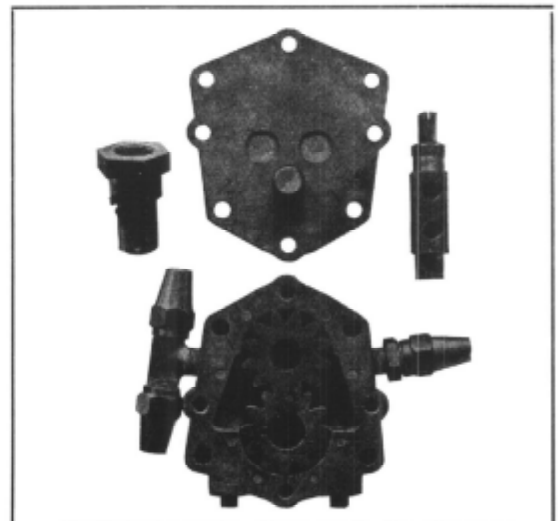

COMPLETE OILING SYSTEM

High-pressure system, consisting of oil pump, camshaft extension, by-pass regulator, oil gauge for dash, all fittings, tubing, and connections, and set of blue prints for installation.

225. Price, complete _____\$36.00

SCINTILLA HIGH-TENSION MAGNETO

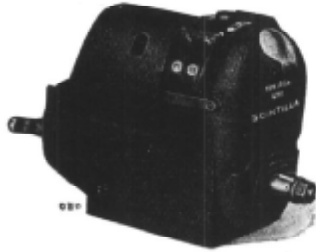

SCINTILLA 2-SPARK MAGNETO.

After exhaustive tests, this was found to be the only magneto to stand up on a Fronty-Ford motor. The Scintilla High-Tension Magneto is fully guaranteed.

227. Price...\$75.00
227A. Price...\$105.00

SPECIAL ZENITH CARBURETOR

We recommend this carburetor for quick get-away and pick-up. Fitted with proper jets for Frontenac racing head.

228. Price...\$35.00

ELBOW ADAPTER or Intake Pipe, to fit Frontenac racing head.

229. Price...\$3.00

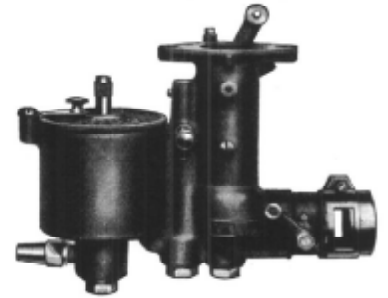

SUB-BASE OIL RESERVOIR

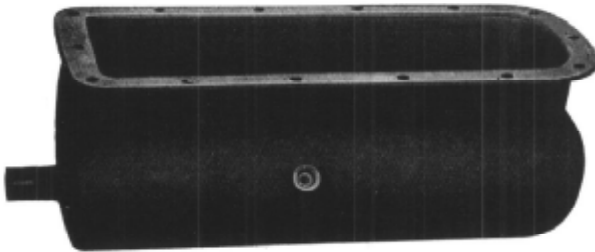

Keeps oil at constant, lower temperature, thus effecting better lubrication of motor at all times. Made of sheet steel, capacity 3 gallons.

230. Price\$25.00

SUB-BASE OIL RESERVOIR made to fit motor with regular Ford front radius rod. Capacity, 2 gallons

231. Price\$20.00

RACING EXHAUST MANIFOLD

Gives that famous "Speedway roar." Made of seamless steel tubing, complete with long 4-in. pipe to the rear of car.

232. Price\$32.50



SPECIAL BALL-BEARING CAP

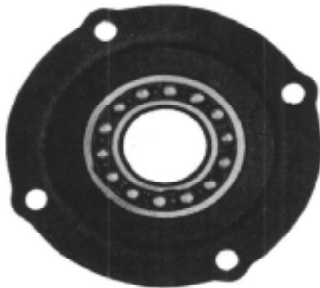

Our special ball-bearing ball cap does away with all trouble with this very troublesome bearing. For all Ford cars.

236. Price\$20.00

COUNTER-BALANCE CRANKSHAFT, drop forged, with standard size bearings, drilled for oil pressure.

233. Price\$40.00

CYLINDER BLOCK fitted with standard size counter-balanced crankshaft, all main and connecting rod bearings fitted. Connecting rods machined and balanced.

234. Price\$120.00

CYLINDER BLOCK fitted with standard size counter-balanced crankshaft, all main and connecting rod bearings fitted. Rods machined and balanced. Special racing pistons, pins and rings, complete oiling system installed, water pump and magneto bracket installed and fitted, breather pipe installed.

235. Price\$275.00

3-IN-1 FRONT PLATE

Especially designed and adapted for fast roadsters. Carries oil pump, water pump and Bosch battery ignition. A very compact and high-grade outfit.

- 237. Non-starter type with raised contact timer, price.....\$25.00
- 238. Starter type with raised contact timer, price..... 25.00
- 239. With Bosch Manual battery ignition, price..... 49.00
- 240. With Bosch Compensating battery ignition, price..... 51.50

SPECIAL CAMSHAFT GEAR. Made of nickel steel.

- 250. Price\$10.00

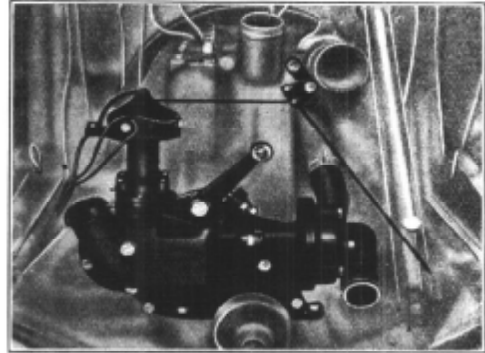

BRONZE FRONT BRACKETS



Manganese bronze front underslung brackets. Very strong. Recommended for racing cars or speedsters.

- 251. Price, per pair.....\$12.00

BRONZE REAR BRACKETS



Manganese bronze rear underslung brackets, very easy to attach.

- 252. Price, per pair.....\$8.00

OVERSIZE AXLE SHAFT

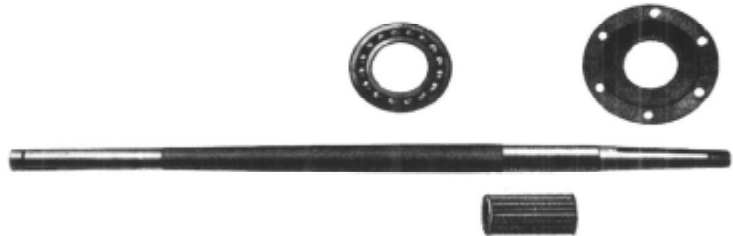

A necessity for racing cars. Protects the driver's life. Should be used with commercial cars carrying heavy loads. Shaft is 1 1/8" diameter, made of electric chrome vanadium steel. (When ordering state width of thread.)

- 253. Price, each\$12.00
- SPECIAL ROLLER BEARINGS** to be used with oversized shaft.
- 254. Price, each\$5.00
- SPECIAL BALL BEARINGS AND HOUSINGS** to replace roller bearings.
- 255. Price, per set, including sleeves for axle tubes.....\$60.00

SPECIAL OFFSET SPRINGS



Special Offset Rear Spring. Adapted especially for half-mile and mile dirt track racing.

- 256. Price\$14.00
- Special Offset Front Spring.
- 257. Price\$6.50

RADIUS RODS FOR RACING

Special radius rods for racing. Made of seamless steel tubing. Very light and strong, the best front construction on the market. (When ordering, state whether or not car is offset.)

- 258. Price per pair, complete with pads and bolts\$24.00



SPRING STEEL STEERING. WHEEL

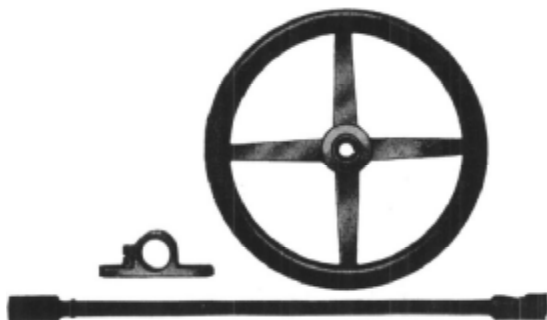

This steering wheel is the same as used on all Speedway cars. The flexible spider protects the driver in any mishap. Used commercially, it completely eliminates fatigue caused by vibration of wheels and absorbs shocks and jars. Nickel plated.

259. Price _____ \$24.00

STEERING GEAR

Strong, durable, safe. Cannot lock when turned to extreme positions. S. A. E. alloyed and heat-treated steels assure long life. There is no stress or wear on housing; no thrust bearings required. Balanced pressure with double leverage. Easily installed. Complete with drag link frame bracket and dash bracket.

260. Price _____ \$40.00

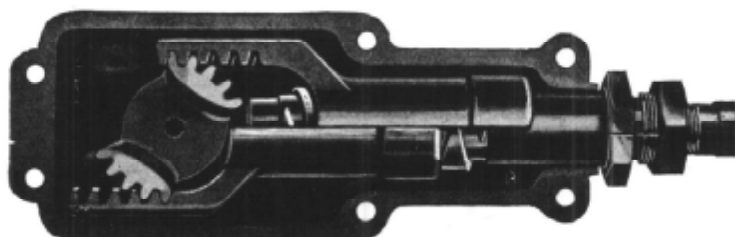

RACING STEERING KNUCKLES

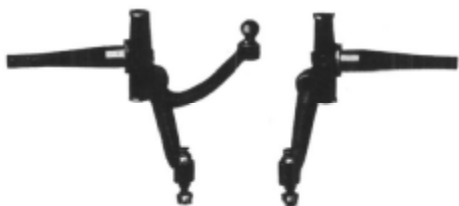

Special racing steering knuckles to fit Ford I-Beam, made of chrome nickel steel; guaranteed against breakage. The best life insurance for the driver. Complete with tie rod and bolts. (When ordering, state width of thread of car.)

261. Price, per pair _____ \$30.00

RACING WIRE WHEELS

Special racing wheels for Ford hubs, 60 spokes, winged hub caps for quick change, clincher rim made for 26x3, 27x3 $\frac{3}{8}$, 28x3, 29x3 $\frac{1}{2}$, 30x3 $\frac{1}{2}$ and 31x4 tires. When ordering state what color is desired, either white, cream, red or black can be furnished.

262. Price per set of 5 wheels and 4 hubs _____ \$75.00

Special 28x4 drop center, straight side racing wheels, equipped with winged hub caps, dental drive, the lightest and fastest wheel to change. Tires cannot be thrown or rolled off this wheel under any conditions.

26. Price per set of 5 wheels and 4 hubs for Fords _____ \$125.00

(Prices for other makes on application.)



SPECIAL WIRE WHEELS FOR PLEASURE CARS

Special 28x4 straight side, flat base wire wheels, non-skid, 28x4 cord tires. These wheels installed on a touring car, coupe or sedan will greatly improve the riding qualities and the acceleration of the car as well as improve its looks.

263A. Price per set of 5 wheels, 5 cord tires and tubes, spare wheel carrier (Winged hub caps if desired) _____ \$175.00

When ordering state what color is desired, either white, cream, black or red.

Special racing tires, straight side, Century or Dayton, made to fit special drop center racing wheel. One set of these tires went through the 500-mile race at Indianapolis without a change.

264. 28x4 Racing Cords, price, each _____ \$83.00

265. 28x4 Inner Tubes, price, each _____ 5.00



HAND PRESSURE PUMP

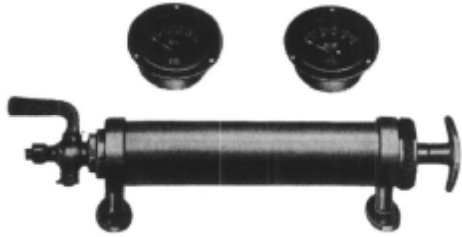

Hand pump for pressure on gasoline and oil tanks, fitted with 3-way valve.

- 266. Brass finish. Price.....\$6.00
- 267. Nickel finish. Price..... 7.00
- 268. Air gauge, 10 lbs.. Price..... 3.00
- 269. Oil gauge, 75 lbs. Price..... 3.00

FILLER CAP

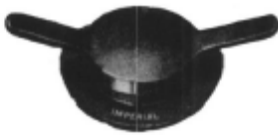

For gasoline and oil tanks. Adds snap to the appearance of any car.

- 270. Brass finish. Price.....\$5.00
- 271. Nickel finish. Price..... 6.00

FRONTY-FORD RADIATOR

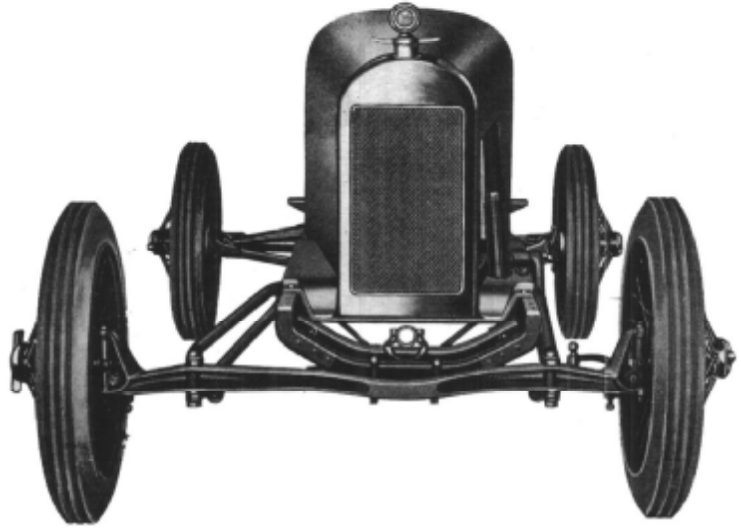

Of special design, with Fedders new high efficiency core. Very effective and beautiful. Unusually well made.

- 272. Price\$75.00
- 273. With Nickel-plated Shell, price..... 85.00

ONE-MAN RACING BODY



One-man type, constructed especially for high-speed dirt track racing. Scientifically designed to give car proper balance and to reduce wind resistance to a minimum. All framework made of angle steel and strongly braced. Very light and strong. All tires can be seen from driver's seat.

(When ordering, give wheelbase of car; state if motor is set back, and if so, how much. Be sure to mention what method of underslinging is used.)

- 274. Price\$125.00

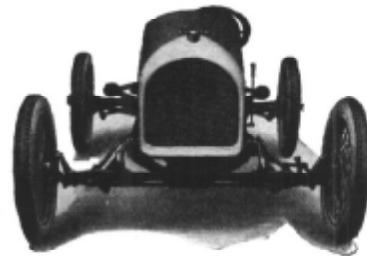

Special nickel-plated shell for Ford radiator. Can be used with either one-man or two-men type of body, and is included in price of body.

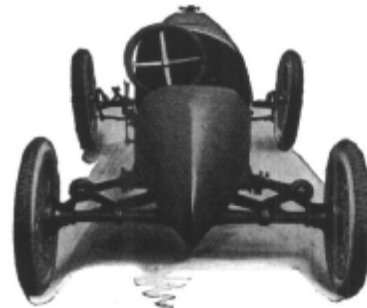

Rear view of special one-man racing body.

SPEEDSTER BODY

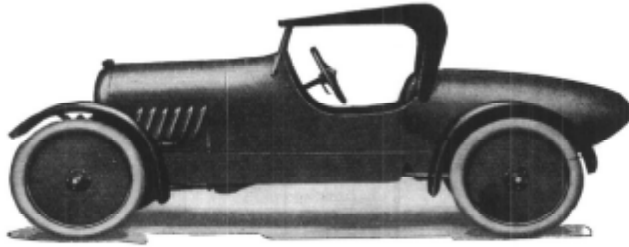

This is our regular speedster body, designed for fast road cars. It is the product of eight years of experience in making special speed bodies for Ford cars. The body has seating accommodations for two full grown persons, is scientifically balanced to insure ease of control at high speeds, and is made to fit the standard Ford frame. Full set of underslung parts is provided.

275. Price\$100.00

EXTRA EQUIPMENT

WINDSHIELD, polished aluminum frame, polished manganese bronze top fittings. Plate glass ground on top edge.

276. Price\$15.00

TOP, tailored of double texture waterproof material. Easily demounted.

277. Price\$22.50

SIDE CURTAINS, perfect fitting, equipped with nickel-plated fasteners.

278. Price\$10.00

FENDERS, made of sheet steel, baked black enamel finish.

279. Price, per set\$24.50

WHEEL DISCS, latest model, add greatly to appearance of car.

280. Price, per set\$6.00

ALUMINUM STEP PLATES, polished aluminum, complete with all necessary fittings. Plates are practically indestructible, and add to strength of step. Installation simple.

281. Price, per set.....\$7.00

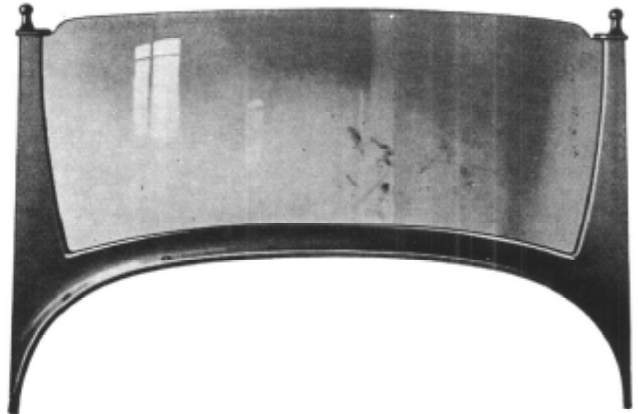

BALANCED PRESSURE STEERING GEAR

Made for Ford Replacement. Makes steering easier and less tiresome. No drilling necessary.

282. Price\$16.50

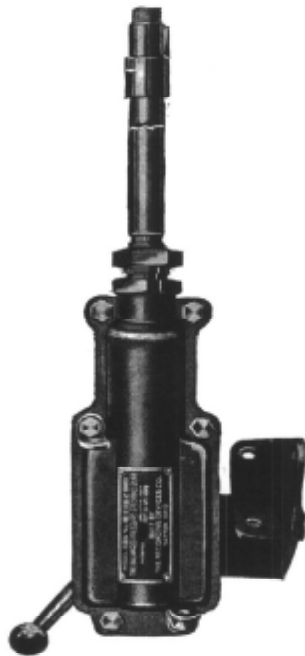

UNDERSLUNG PARTS

UNDERSLUNG PARTS

For speedster or road car. Correctly designed and easy to install.

283. Price, per set...\$40.00

3-1 GEAR RATIO

284. Price\$15.00

3/8" RACING PLUGS

285. Price, each\$1.50

SPECIAL METRIC RACING PLUGS

286. Price, each\$2.00



WATER PUMP AND MAGNETO BRACKET PARTS LIST

Name.	Number Reg'd	Price	Name.	Number Reg'd	Price
Front gear cover	1	\$ 8.50	Water pump shaft bearing	1	6.50
Main bracket	1	12.00	Water pump shaft bearing retainer...	1	2.00
Water pump body	1	8.00	Water pump shaft bearing retainer		
Water pump cover	1	8.00	bolts, each	3	.10
Water pump bushing, each	2	.50	Water pump cover screws (short)...	6	.10
Water pump impeller	1	2.00	Water pump cover screws (long)....	1	.15
Water pump packing nut, R. H.	1	1.00	Water pump anchor bolts each.....	2	.15
Water pump packing nut, L. H.	1	1.00	Water manifold	1	7.50
Water pump alemite connections, each	2	.30	Water manifold studs each	6	.10
Water pump Woodruff key	1	.10	Water manifold studs nuts, each....	6	.05
Water pump taper pin	1	.10	Bracket bolt (long)	1	.20
Water pump shaft	1	5.00	Bracket bolt (short)	1	.15
Water pump shaft driving gear.....	1	3.00			

OILING SYSTEM PARTS LIST

Name.	Number Reg'd	Price	Name.	Number Reg'd	Price
Oil pump, complete	1	\$12.00	¾ elbow overflow return.....	1	.40
Oil pump body	1	5.00	¾ copper tubing intake line.....	1	.80
Oil pump cover	1	3.50	¾ rubber tubing intake line.....	1	.40
Oil pump driving gear (steel)	1	3.00	¾ copper tub. from pump to first tee..	1	.50
Oil pump driven gear (bronze)	1	2.00	¾ tubing from tee to by-pass.....	1	.40
Cam shaft extension	1	5.00	¾ rubber hose to by-pass.....	1	.40
By-pass	1	4.00	¼ copper tubing, leads to main		
¾ elbow on base	1	.50	bearings, each.....	3	.20
¾ union on pump, each	2	.50	¼ tub. from by-pass to gauge.....	1	.60
¾ front outside tee	1	1.00	¼ tubing from gauge line to rear		
¼ front inside tee	1	.80	transmission bearing	1	.80
¼ rear inside elbow, also used on			¾ tubing overflow line.....	1	.50
bearing caps, each	4	.30	¼ rubber hose gauge line.....	1	.30
¼ union to gauge line	1	.35	¼ rubber hose rear trans. line.....	1	.30
¾ union to overflow line.....	1	.40	¾ rubber hose overflow line.....	1	.35
¼ tee to rear trans. bear.....	1	.80	Oil pump cap screws, each.....	8	.10
¼ elbow to rear trans. bear.....	1	.50			

INDEX

	Page.		Page.
Axle shaft	7	Pistons	6
Bodies	9-10	Piston pins	5
Ball bearing cap	6	Piston rings	5
Ball bearing wheel	7	Pump oil	5
Bearings (roller)	7	Pump (pressure)	9
Cylinder heads	2	Racing car	3
Crankshaft	4-6	Racing motor	4
Connecting Rods	4	Radius rods	7
Cylinder blocks	4-6	Radiator	9
Carburetors	6	Radiator shell	9
Commercial tires and wheels.....	8	Springs	7
Exhaust pipe (racing)	6	Steering wheel	8
Filler caps	9	Steering gear	8-10
Front plate	7	Steering knuckles	8
Gauges	9	Steps	10
Gears, Ratio	10	Spark plugs	10
Motor	4	Tires	8
Magneto	6	Underslung parts	7-10
Oiling system	5	Water pump	5-7
Oil reservoir	6	Wheels (wire)	8
		Windshield	10

WHEN ORDERING, to avoid error, state both the number and name of the parts desired. Be sure to specify method of shipment. Send 25 per cent. of the price with the order; the balance to be paid C. O. D.

Our book, "How to Build a Fronty-Ford," gives complete detailed instructions on how to construct a Fronty-Ford Racing Car. It will be sent on receipt of \$2.00, or free of charge with orders amounting to \$50.00 or more.

Chevrolet Bros. Mfg. Co.

410 West Tenth Street

INDIANAPOLIS, IND.